



PERMIT TO OCCUPY THE PUBLIC RIGHT-OF-WAY

Sec. 16-121.(b) Work done without a permit. The fee for failure to obtain a permit is four times the permit fee.

Permit # :	_____
Effective Date:	5-11-26
Expiration Date:	Permanent
Non-Refundable Fee:	40.00
Receipt # :	10305-0003

REV. 01/2026

Applicant Information

Name (Print) Jennifer Stephany Company: Appleton Downtown, Inc.
 Address: 333 W College Ave STE 100 E-mail: jennifer@appletondowntown.org
 City,State, Zip: Appleton, WI 54911 Telephone: 9209549112

Occupancy Information

General request to occupy the alleyway behind the 222 W College Ave building to string cables and Edison light strands
 Description/Reason: request to occupy the alleyway behind the 222 W College Ave building to string cables and Edison light strands between 222 W College Ave and 221 W Washington St.
 Street Address: alleyway behind 222 W College Ave Sidewalk/roadway obstruction requested Y or N
 - or - Multiple Streets: _____
 Dates (s) From: 5-11-26 To: Permanent 35 days or < 35 days or >
 (Requires Committee and Council Approval)

This permit approval is subject to the following conditions:

1. Permittee is responsible to obtain any further permits that may be required as part of this occupancy.
2. Permittee shall adhere to any plan(s) that were submitted to the City of Appleton as part of this application.
3. This permit is subject to IMMEDIATE REVOCATION and/or issuance of a MUNICIPAL CITATION if conditions of the permit are not met.
4. This permit is subject to IMMEDIATE REVOCATION if unfavorable traffic conditions develop during the period the occupancy is permitted.
5. Dumpsters/PODs/Containers shall be located within 12" of face of curb.
- 6.

This permit is issued to the applicant upon payment of the permit fee and is expressly limited to the location and type described herein. The applicant, in exchange for receiving this permit, warrants that all street occupancies will be performed in conformity to City ordinances, standards and policies, be properly barricaded and lighted, and be performed in a safe manner. By applying for and accepting this permit, the applicant assumes full liability and/or any costs incurred by the City for corrective work required to bring the subject area into compliance with said ordinances, standards, policies and permit conditions. No occupancy shall occur prior to approval of this permit by the Department of Public Works.

The Grantee shall guarantee at their expense, the repair or replacement of pavement, sidewalk and any other facilities within the public right-of-way damaged or destroyed by the Grantee or any subcontractor working for them. The Grantee shall assume complete and full liability and responsibility, in accordance with existing ordinances and policies, in the event of injury or damage to persons or property resulting from their facilities within the public right-of-way.

SIGNED BY: _____
(Applicant)

Jennifer Stephany

DATE: 5/6/26

(Department use only)

Occupancy Type

- Permanent - Obstruction (\$40)
 Temporary - Obstruction (\$40)
 Amenity/Annual (\$40)
 Blanket/Annual (\$250)
 Block Party (\$15)

Sub-Type

- Awning
 Dumpster
 Sign
 Obstruction / Other
 POD / Container

Location

- Sidewalk
 Terrace
 Roadway

Additional Requirements

Construction Plan/Sketch Certificate of Insurance Bond Committee and Council Approval
 Other: _____ Date: _____

Work Zone Traffic Control Requirements

Type of Street: Arterial/CBD Collector Local
 Proposed Traffic Control: City Manual Page(s) _____ State Manual Page(s) _____ Other (attach plan) _____

Contact Traffic Division at 920-832-2304 or traffic.engineering@appletonwi.gov 1 business day prior to any lane closure, or 2 business days prior to a full road closure.

Additional Requirements:

Approved by: _____

Date: _____

APPROVED BY: _____

DATE: _____

(Department of Public Works)



CERTIFICATE OF LIABILITY INSURANCE

DATE (MM/DD/YYYY)

03/17/2026

THIS CERTIFICATE IS ISSUED AS A MATTER OF INFORMATION ONLY AND CONFERS NO RIGHTS UPON THE CERTIFICATE HOLDER. THIS CERTIFICATE DOES NOT AFFIRMATIVELY OR NEGATIVELY AMEND, EXTEND OR ALTER THE COVERAGE AFFORDED BY THE POLICIES BELOW. THIS CERTIFICATE OF INSURANCE DOES NOT CONSTITUTE A CONTRACT BETWEEN THE ISSUING INSURER(S), AUTHORIZED REPRESENTATIVE OR PRODUCER, AND THE CERTIFICATE HOLDER.

IMPORTANT: If the certificate holder is an ADDITIONAL INSURED, the policy(ies) must have ADDITIONAL INSURED provisions or be endorsed. If SUBROGATION IS WAIVED, subject to the terms and conditions of the policy, certain policies may require an endorsement. A statement on this certificate does not confer rights to the certificate holder in lieu of such endorsement(s).

PRODUCER Truyma Haase Zahn Insurance Group 114 S Main St PO Box 6 Seymour, WI 54165	CONTACT NAME: PHONE (A/C No. Ext): (920) 833-6871 FAX (A/C, No): (920) 833-6870 E-MAIL ADDRESS: info@thzins.com	
	INSURER(S) AFFORDING COVERAGE	
INSURED Appleton Downtown Inc PO Box 2272 Appleton, WI 54912	INSURER A: Secura Insurance NAIC # 22543	
	INSURER B: The Hartford HARTF1	
	INSURER C:	
	INSURER D:	
	INSURER E:	
	INSURER F:	

COVERAGES**CERTIFICATE NUMBER:****REVISION NUMBER:**

THIS IS TO CERTIFY THAT THE POLICIES OF INSURANCE LISTED BELOW HAVE BEEN ISSUED TO THE INSURED NAMED ABOVE FOR THE POLICY PERIOD INDICATED. NOTWITHSTANDING ANY REQUIREMENT, TERM OR CONDITION OF ANY CONTRACT OR OTHER DOCUMENT WITH RESPECT TO WHICH THIS CERTIFICATE MAY BE ISSUED OR MAY PERTAIN, THE INSURANCE AFFORDED BY THE POLICIES DESCRIBED HEREIN IS SUBJECT TO ALL THE TERMS, EXCLUSIONS AND CONDITIONS OF SUCH POLICIES. LIMITS SHOWN MAY HAVE BEEN REDUCED BY PAID CLAIMS.

INSR LTR	TYPE OF INSURANCE	ADDL INSD	SUBR WVD	POLICY NUMBER	POLICY EFF (MM/DD/YYYY)	POLICY EXP (MM/DD/YYYY)	LIMITS	
A	<input checked="" type="checkbox"/> COMMERCIAL GENERAL LIABILITY <input type="checkbox"/> CLAIMS-MADE <input checked="" type="checkbox"/> OCCUR GEN'L AGGREGATE LIMIT APPLIES PER: <input checked="" type="checkbox"/> POLICY <input type="checkbox"/> PRO-JECT <input type="checkbox"/> LOC OTHER:	Y		CP3301626	04/15/2026	04/15/2027	EACH OCCURRENCE	\$ 1,000,000
							DAMAGE TO RENTED PREMISES (Ea occurrence)	\$ 500,000
							MED EXP (Any one person)	\$ 10,000
							PERSONAL & ADV INJURY	\$ 1,000,000
							GENERAL AGGREGATE	\$ 2,000,000
							PRODUCTS - COMP/OP AGG	\$ 2,000,000
								\$
	AUTOMOBILE LIABILITY <input type="checkbox"/> ANY AUTO <input type="checkbox"/> OWNED AUTOS ONLY <input type="checkbox"/> SCHEDULED AUTOS <input type="checkbox"/> HIRED AUTOS ONLY <input type="checkbox"/> NON-OWNED AUTOS ONLY						COMBINED SINGLE LIMIT (Ea accident)	\$
							BODILY INJURY (Per person)	\$
							BODILY INJURY (Per accident)	\$
							PROPERTY DAMAGE (Per accident)	\$
								\$
A	<input checked="" type="checkbox"/> UMBRELLA LIAB <input type="checkbox"/> OCCUR <input type="checkbox"/> EXCESS LIAB <input type="checkbox"/> CLAIMS-MADE <input type="checkbox"/> DED <input checked="" type="checkbox"/> RETENTION \$ 10000			CU3301635	04/15/2026	04/15/2027	EACH OCCURRENCE	\$ 1,000,000
							AGGREGATE	\$ 1,000,000
								\$
B	WORKERS COMPENSATION AND EMPLOYERS' LIABILITY ANY PROPRIETOR/PARTNER/EXECUTIVE OFFICER/MEMBER EXCLUDED? (Mandatory in NH) If yes, describe under DESCRIPTION OF OPERATIONS below	Y/N	N/A	83WECAC9T18	04/15/2026	04/15/2027	<input checked="" type="checkbox"/> PER STATUTE <input type="checkbox"/> OTHER	
							E.L. EACH ACCIDENT	\$ 100,000
							E.L. DISEASE - EA EMPLOYEE	\$ 100,000
							E.L. DISEASE - POLICY LIMIT	\$ 500,000
A	Directors & Officers Liability			CP3301626	4/15/2026	4/15/2027	Per Occurrence	\$1,000,000
A	Liquor Liability			CP3301626	4/15/2026	4/15/2027	Per Occurrence	\$1,000,000

DESCRIPTION OF OPERATIONS / LOCATIONS / VEHICLES (ACORD 101, Additional Remarks Schedule, may be attached if more space is required)

Parklet - 201 N APPLETON ST,

City of Appleton as additional insured - when required by contract per form CGT1000
 Commercial Umbrella follows forms of underlying policies.

CERTIFICATE HOLDER**CANCELLATION**

City Of Appleton 100 N. Appleton Street Appleton, WI 54911	SHOULD ANY OF THE ABOVE DESCRIBED POLICIES BE CANCELLED BEFORE THE EXPIRATION DATE THEREOF, NOTICE WILL BE DELIVERED IN ACCORDANCE WITH THE POLICY PROVISIONS. AUTHORIZED REPRESENTATIVE 
--	--

© 1988-2015 ACORD CORPORATION. All rights reserved.



CERTIFICATE OF LIABILITY INSURANCE

DATE (MM/DD/YYYY)

03/17/2026

THIS CERTIFICATE IS ISSUED AS A MATTER OF INFORMATION ONLY AND CONFERS NO RIGHTS UPON THE CERTIFICATE HOLDER. THIS CERTIFICATE DOES NOT AFFIRMATIVELY OR NEGATIVELY AMEND, EXTEND OR ALTER THE COVERAGE AFFORDED BY THE POLICIES BELOW. THIS CERTIFICATE OF INSURANCE DOES NOT CONSTITUTE A CONTRACT BETWEEN THE ISSUING INSURER(S), AUTHORIZED REPRESENTATIVE OR PRODUCER, AND THE CERTIFICATE HOLDER.

IMPORTANT: If the certificate holder is an ADDITIONAL INSURED, the policy(ies) must have ADDITIONAL INSURED provisions or be endorsed. If SUBROGATION IS WAIVED, subject to the terms and conditions of the policy, certain policies may require an endorsement. A statement on this certificate does not confer rights to the certificate holder in lieu of such endorsement(s).

PRODUCER Truyma Haase Zahn Insurance Group 114 S Main St PO Box 6 Seymour, WI 54165	CONTACT NAME: PHONE (A/C No. Ext): (920) 833-6871 FAX (A/C, No): (920) 833-6870 E-MAIL ADDRESS: info@thzins.com	
	INSURER(S) AFFORDING COVERAGE	
INSURED Appleton Downtown Inc PO Box 2272 Appleton, WI 54912	INSURER A: Secura Insurance NAIC # 22543	
	INSURER B: The Hartford HARTF1	
	INSURER C:	
	INSURER D:	
	INSURER E:	
	INSURER F:	

COVERAGES**CERTIFICATE NUMBER:****REVISION NUMBER:**

THIS IS TO CERTIFY THAT THE POLICIES OF INSURANCE LISTED BELOW HAVE BEEN ISSUED TO THE INSURED NAMED ABOVE FOR THE POLICY PERIOD INDICATED. NOTWITHSTANDING ANY REQUIREMENT, TERM OR CONDITION OF ANY CONTRACT OR OTHER DOCUMENT WITH RESPECT TO WHICH THIS CERTIFICATE MAY BE ISSUED OR MAY PERTAIN, THE INSURANCE AFFORDED BY THE POLICIES DESCRIBED HEREIN IS SUBJECT TO ALL THE TERMS, EXCLUSIONS AND CONDITIONS OF SUCH POLICIES. LIMITS SHOWN MAY HAVE BEEN REDUCED BY PAID CLAIMS.

INSR LTR	TYPE OF INSURANCE	ADDL INSD	SUBR WVD	POLICY NUMBER	POLICY EFF (MM/DD/YYYY)	POLICY EXP (MM/DD/YYYY)	LIMITS	
A	<input checked="" type="checkbox"/> COMMERCIAL GENERAL LIABILITY <input type="checkbox"/> CLAIMS-MADE <input checked="" type="checkbox"/> OCCUR GEN'L AGGREGATE LIMIT APPLIES PER: <input checked="" type="checkbox"/> POLICY <input type="checkbox"/> PRO-JECT <input type="checkbox"/> LOC OTHER:	Y		CP3301626	04/15/2026	04/15/2027	EACH OCCURRENCE	\$ 1,000,000
							DAMAGE TO RENTED PREMISES (Ea occurrence)	\$ 500,000
							MED EXP (Any one person)	\$ 10,000
							PERSONAL & ADV INJURY	\$ 1,000,000
							GENERAL AGGREGATE	\$ 2,000,000
							PRODUCTS - COMP/OP AGG	\$ 2,000,000
								\$
	AUTOMOBILE LIABILITY <input type="checkbox"/> ANY AUTO <input type="checkbox"/> OWNED AUTOS ONLY <input type="checkbox"/> SCHEDULED AUTOS <input type="checkbox"/> HIRED AUTOS ONLY <input type="checkbox"/> NON-OWNED AUTOS ONLY						COMBINED SINGLE LIMIT (Ea accident)	\$
							BODILY INJURY (Per person)	\$
							BODILY INJURY (Per accident)	\$
							PROPERTY DAMAGE (Per accident)	\$
								\$
A	<input checked="" type="checkbox"/> UMBRELLA LIAB <input type="checkbox"/> OCCUR <input type="checkbox"/> EXCESS LIAB <input type="checkbox"/> CLAIMS-MADE <input type="checkbox"/> DED <input checked="" type="checkbox"/> RETENTION \$ 10000			CU3301635	04/15/2026	04/15/2027	EACH OCCURRENCE	\$ 1,000,000
							AGGREGATE	\$ 1,000,000
								\$
B	WORKERS COMPENSATION AND EMPLOYERS' LIABILITY ANY PROPRIETOR/PARTNER/EXECUTIVE OFFICER/MEMBER EXCLUDED? (Mandatory in NH) If yes, describe under DESCRIPTION OF OPERATIONS below	Y/N	N/A	83WECAC9T18	04/15/2026	04/15/2027	<input checked="" type="checkbox"/> PER STATUTE <input type="checkbox"/> OTHER	
							E.L. EACH ACCIDENT	\$ 100,000
							E.L. DISEASE - EA EMPLOYEE	\$ 100,000
							E.L. DISEASE - POLICY LIMIT	\$ 500,000
A	Directors & Officers Liability			CP3301626	4/15/2026	4/15/2027	Per Occurrence	\$1,000,000
A	Liquor Liability			CP3301626	4/15/2026	4/15/2027	Per Occurrence	\$1,000,000

DESCRIPTION OF OPERATIONS / LOCATIONS / VEHICLES (ACORD 101, Additional Remarks Schedule, may be attached if more space is required)

City of Appleton as additional insured - when required by contract per form CGT1000

Commercial Umbrella follows forms of underlying policies.

CERTIFICATE HOLDER**CANCELLATION**

City of Appleton 100 N Appleton St Appleton, WI 54911	SHOULD ANY OF THE ABOVE DESCRIBED POLICIES BE CANCELLED BEFORE THE EXPIRATION DATE THEREOF, NOTICE WILL BE DELIVERED IN ACCORDANCE WITH THE POLICY PROVISIONS. AUTHORIZED REPRESENTATIVE 
---	--

© 1988-2015 ACORD CORPORATION. All rights reserved.

COMMERCIAL STRAND LIGHT ^{120V}



tivoli®

Strand & Light Engine



TCSL-S-X-24-120
X = B (black), **W*** (white)
 48' length, 24" spacing with
 molded male and female end

*Consult Factory for MOQ

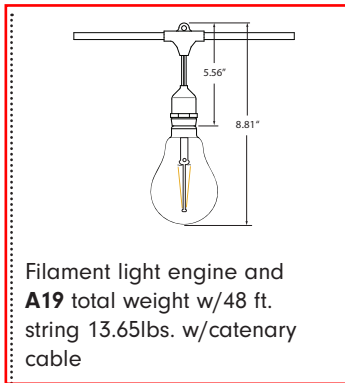

Filament light engine and
A19 total weight w/48 ft.
 string 13.65lbs. w/catenary
 cable

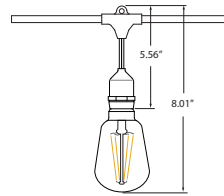

Filament light engine and
S14 total weight w/48 ft.
 string 13.65 lbs. w/catenary
 cable

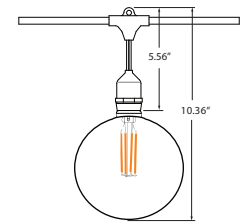

Filament light engine and
G120 total weight w/48 ft.
 string 17.25 lbs. w/catenary
 cable

Specification - Strand

Commercial String Light	
Socket Spacing	24"
Socket Type	E26
Socket Count	24
Cord Length	48' with male and female molded ends
Cord Type	3C x 14AWG SJTW
Cord Plug	5-15P Polarized
Cord Weight	7.85 lbs.
Operating Voltage	120V AC

Certification and Testing	
Certification	cETLus
Environment	Wet Location
IP Rating	IP65
Lifetime Hours (Light Engine)	15,000
Warranty	5 Years

Max Wattage (not to exceed 960W total run length)										
Strand Count	1	2	3	4	5	6	7	8	9	10
Wattage/Socket	40	20	13.3	10	8	6.6	5.7	5	4.4	4

EPA - 48' Run							
Type	G120	A19/ S14	Hat 8"	Hat 13"	Dish 10"	Flower 10"	Flower 13"
Spacing 24"	5.04	CF	6.80	16.95	10.08	10.08	16.95



Order Guide - PC/PET

PRODUCT CODE	TYPE	FILAMENT	FINISH	SOCKET	LED COLOR	VOLTAGE
TVLTPC TVLT = Tivolite PC Bulb	S14 S14 = S14 Bulb	1 = 1 Filament 2 = 2 Filament	F = Frosted V = Vintage C = Clear	26 26 = E26	22 = 2200K 24 = 2400K 27 = 2700K 30 = 3000K	120 120 = 120V AC

PRODUCT CODE	TYPE	FILAMENT	FINISH	SOCKET	LED COLOR	VOLTAGE
TVLTPET TVLT = Tivolite PET Bulb	A19 A19 = A19 Bulb	1 = 1 Filament 2 = 2 Filament 4 = 4 Filament	F = Frosted V = Vintage C = Clear	26 26 = E26	22 = 2200K 24 = 2400K 27 = 2700K 30 = 3000K	120 120 = 120V AC

Order Guide - Glass

PRODUCT CODE	TYPE	FILAMENT	FINISH	SOCKET	LED COLOR	VOLTAGE
TVLT TVLT = Tivolite Bulb	A19 = A19 Bulb S14 = S14 Bulb	1 = 1 Filament 2 = 2 Filament 4 = 4 Filament 6 = *6 Filament	F = Frosted V = Vintage C = Clear	26 26 = E26	22 = 2200K 24 = 2400K 27 = 2700K 30 = 3000K	120 120 = 120V AC

*Note: Available only in A19 type glass

Specification - Light Engine

1 Filament (Clear 2200K)	A19	S14	2 Filament (Clear 2200K)	A19	S14	4 Filament (Clear 2700K)	A19	S14 (glass only)	6 Filament (Clear 3000K)	A19 (glass only)
Lumens (lm/fixture)	45	45	Lumens (lm/fixture)	105	105	Lumens (lm/fixture)	CF	400	Lumens (lm/fixture)	717.6
Efficacy (lm/W)	45	45	Efficacy (lm/W)	52.5	52.5	Efficacy (lm/W)	CF	100	CRI	84.8
CRI	>80		CRI	>80		CRI	>80		Efficacy (lm/W)	115.7
Power Consumption	1W	1W	Power Consumption	2W	2W	Power Consumption	4W	4W	Power Consumption	6.2W

Control	
Dimming	ELV, TRIAC
Electrical	
Input Voltage	120V AC
Physical	
Bulb	Vacuum Sealed
Base	Nickle Coated Brass
Certification and Testing	
Certification	ETL
IP Rating	IP65, Outdoor Location
Rated Life	30,000 hrs.
Warranty	5 years



Order Guide - PET

PRODUCT CODE	TYPE	FILAMENT	FINISH	SOCKET	LED COLOR	VOLTAGE
TVLTPET TVLTPET = Tivolite PET Bulb	G120 G120 = G120 Bulb	4 4 = 4 Filament	C C = Clear	26 26 = E26	24 = 2400K 27 = 2700K	120 120 = 120V AC

Specification - Light Engine

4 Filament (Clear 2700K)	G120
Lumens (lm/fixture)	361.5
CRI	91.5
Efficacy (lm/W)	93.9
Measured Power Consumption	3.8W
Power Consumption	4W

Control	
Dimming	See Chart Below
Electrical	
Input Voltage	120V AC
Physical	
Bulb	Vacuum Sealed
Base	Nickle Coated Brass
Certification and Testing	
Certification	cULus
IP Rating	IP65, Outdoor Location
Rated Life	10,000 hrs.
Warranty	5 years

Dimmer Compatability

Lutron Masestro	MACL-153MLH-WH
Lutron Diva Gen3	FWCL-153PH-WH
Eaton	HALO SALO6P
Lutron -CL-Diva	DVWCL-153PH
Lutron -CL-Toggler	TGCL-153PH
Lutron -CL-Skylark	CTCL-153DP
Lutron -CL-Maestro	MACL-153MR-WH
Lutron -CL-Diva	DVCL-153P
Lutron -ELV-Diva ELV	DVELV-300P
Lutron -ELV-Skylark ELV	SELV-300P

Mounting Accessories

Warning: For suspension application, catenary cable is required to support the product, otherwise the warranty will be void.



LS-CABLE-X
X = 60 (60'), **110** (110'),
500 (500')
 1/8" Galvanized cable in-
 cludes (2) cable locks for use
 with loads up to 200lbs
 Note: 500' no locks included



LS-LOCK-X
X = 2 (2 pcs), **4** (4 pcs)
 Includes (1) release key
 Cable Lock for 1/8" cable,
 support loads up to 200 lbs.



LS-TT
 Cable tensioning tool up to
 880lbs with 6:1 gear drive with
 integral torque gauge controls



LS-UVZP-BK-XX
XX = 30 (30 pcs), **50** (50 pcs)
 Black UV resistant, heavy duty
 ties maximum weight up to
 100 lbs./per tie

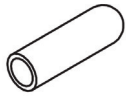

TCSL-BK-EC
 PVC Field Cut End-Cap, Black

Light Shade Accessories

Note: Light Shade needed for DarkSky compliance

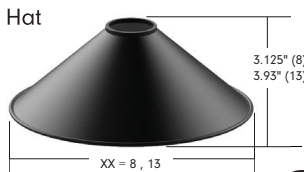

SHADE-HT-BK-XX-XX
XX = BK (black), **CO*** (copper)
XX = 8 (8.3"), **13**** (12.6")
 Black top, black/copper bottom
 Weight: 0.46 lb (8), 1.2 lb (13)

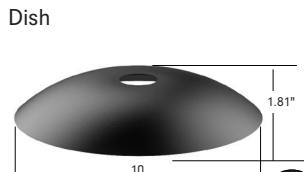

SHADE-DS-BK-BK-10
 10.2" Black top, black bottom
 Weight: 0.76 lb

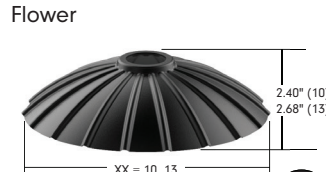

SHADE-FL-BK-BK-XX
XX = 10 (9.8"), **13** (13.8")
 Black top, black bottom
 Weight: 0.63 lb (10), 1.48 lb (13)



SHADE-ADP-CSL-BK-XX
XX = 25 (25 pcs), **01** (1 pc)
 PVC shade adapters black
Note: One adaptor required for each
 shade

*Only available for 13 (Hat)

**Consult factory for lead time and MOQ